

USER INSTRUCTIONS

Welcome to the family of SUPER SOCO owners! We will guide you to know every function for the right and safe use of TC-MAX smart electric bikes. To ensure your safety, please read this manual carefully before riding and make sure you are always following the requirements below:

- 1 Fully understand the information in this manual, including but not limited to the relevant instructions, precautions and warnings.
- 2 Fully understand the operation and contingency measures of TC-MAX smart electric bikes.
- 3 Be fully aware of warning labels of TC-MAX smart electric bikes.
- 4 Do not disassemble the electric bike and parts without permission, Please contact customer service department and dealers if you need any replacement or do further purchase.
- 5 Please keep this User Manual properly



Warning

All parameters have been permanently set according to national standards before delivery, our company is not responsible for anything change like the original electrical circuit ,wire harness and maximum speed.

Please contact the SUPER SOCO Customer Service Center 400-021-2008 if you have any questions about this bike. We are at our service at any time. Wish you safe and pleasant riding experience!

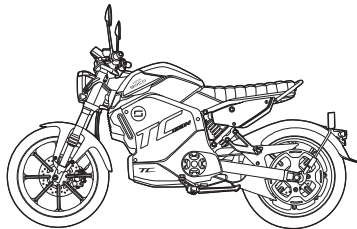

SAFETY INSTRUCTIONS

To ensure the safety of you and others, please make sure to observe the following matters:

- 1** Please do not lend your vehicle to someone who can not control it to avoid injury
- 2** Minors under 16 years old is not allowed to ride our bike on the road.
- 3** Please ride your bike in the bicycle lane, do not exceed the maximum speed (Keep right on the road if there is no bicycle lane)
- 4** Do not ride after you take medications which may effect your riding ability, drink alcohol or when you feel physically upset.
- 5** Observe traffic regulations and traffic signs,manned and loaded in accordance with local laws and regulations and confirm the surrounding road conditions and bike's conditions at any time, so as to actively avoid danger.
- 6** In case of rain and snow, the braking distance shall be increased. Pay attention to slowing down the speed.Try to avoid traveling as much as possible in inclement weather condition.
- 7** Wear safety equipment, such as helmet, and appropriate protective clothing if necessary, such as gloves and boots.
- 8** In order to ensure the safety of you and others, please DO NOT use high beam in good lighting conditions. The continuous use of high beam will cause the visual disturbance to vehicles and pedestrians on the opposite side, affecting normal driving.
- 9** Please turn off the power , remove the key immediately after riding. Keep away from the children, avoid the loss of your family and property.
- 10** Perform a basic check each time before riding, so as to confirm the light, brake, tread and tire pressure and check other parts for looseness or abnormal noise, and regularly go to official dealer's service center for maintenance.

SAFETY INSTRUCTIONS

- 11** Check before riding. In case of any abnormality, please timely repair or go to official dealer's service center.
- a.** Check the power circuit, lighting circuit statuses etc.
 - b.** Check whether the front and rear brakes work properly
 - c.** Check the handlebar and the front and rear wheels fixing
 - d.** Check the tire pressure
 - e.** Check the belt whether loose or damaged
 - f.** Check the belt wheels whether it is damaged
 - g.** Check the belt whether belt wheel tooth groove

QUICK START

- 01 - PARTS INSPECTION



× **2**

Quick Start



× **1**

Mirrors



× **1**

User manual



× **2**

Keys



× **1**

Spanner for mirrors



× **1**

Charger

QUICK START

- 02 - INSTALL BATTERY PACK

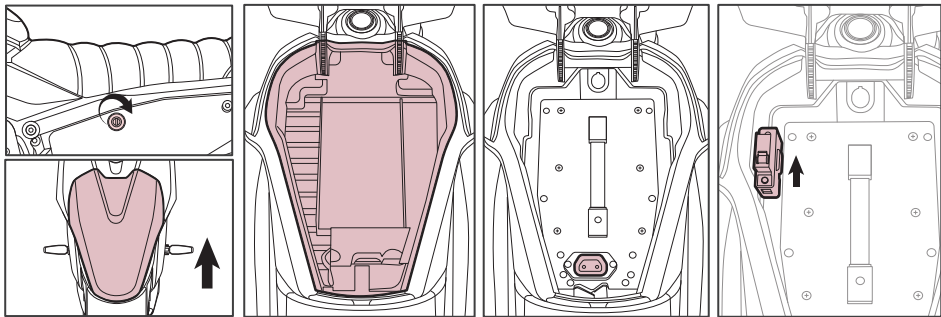

- 1** Open storage, take out cover.
- 2** Put battery package in.
- 3** Connect power plug.
- 4** Switch of circuit protector, put cover back and close storage.

QUICK START

- 03 - IGNITE TC-MAX

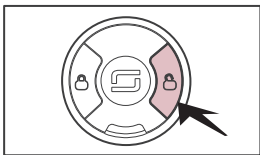

- 1** Press 'UNLOCK' on remote control, "POWER" button on.

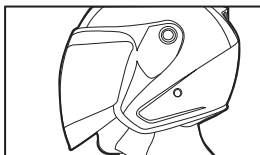

- 2** Put helmet on.

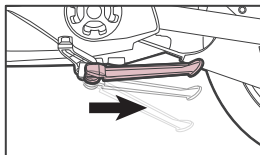

- 3** Get on TC-MAX, kick side stand out.

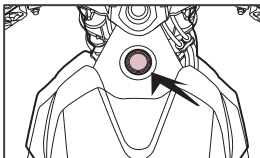

- 4** Press 'Power', power on.

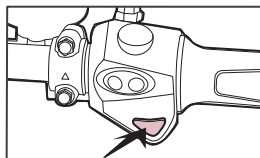

- 5** Press 'Parking' button, unpacking TC-MAX, parking symbol off.

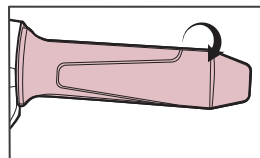

- 6** Turn accelerator gently, TC-MAX run.

- 04 - DOWNLOAD APP

TC-MAX smart electric bikes has GPRS function,can connect with your smart phone.

By APP,you can use smart phone to manage and query your TC-MAX.

Only IOS and Android are currently available now,
please confirm your smart phone operating system in advance.

IOS system:APP only support Apple ISO 9.0 system and above.

Android system: APP only support Android 4.4 system and above.

Download and install the SUPER SOCO APP by QR code in this manual or key box.



SUPERSOCO

Tips: Super soco APP is additional function.

2 years free network traffic will be provided since the day of new bike been sold. Please contact with our official dealer or use online charging system to charge it one month before expiration.(APP online charging system will be online in 2021). Overdue recharge will cause the APP function to be disabled and SIM card log out.

CONTENTS

Description of Components and Parts **09**

Operation guide **12**

Riding guider **17**

Battery use instruction **20**

App instruction **23**

Maintenance **24**

FAQ & Trouble shooting **25**

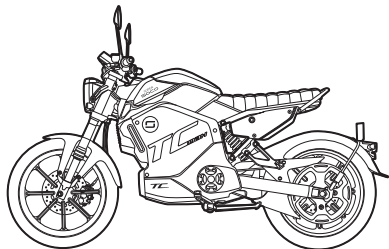

DESCRIPTION OF COMPONENTS AND PARTS

A. SCHEMATIC DIAGRAM OF COMPONENTS AND PARTS

SIDE VIEW

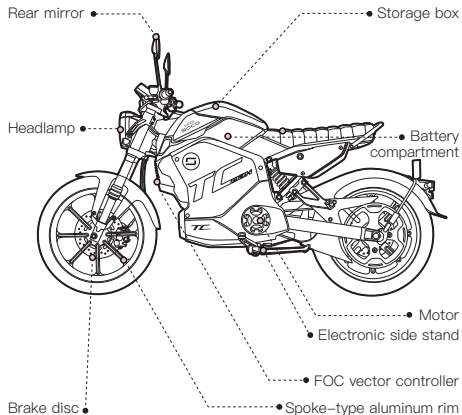

TOP VIEW

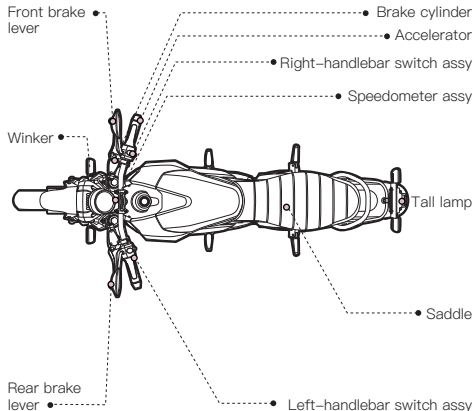

DESCRIPTION OF COMPONENTS AND PARTS

B. DIAGRAM OF SPEEDOMETER

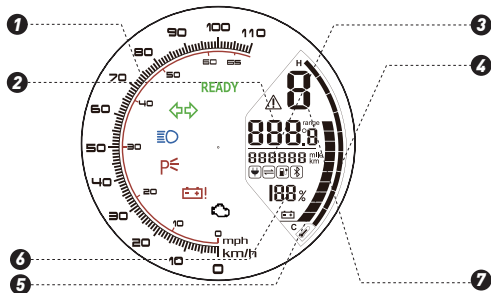

1 Speed

Display current speed

2 Temperature & distance

Distance per charge/ trip distance/
rotating speed, ambient temperature

3 Total mileage

Display the total mileage

4 Controller temperature

Display the temperature under
current operating conditions

5 Power display bar

Display current battery power
level

6 Battery percentage display

Display the current battery power
percentage

7 Gear Display

Display current driving gear.

DESCRIPTION OF COMPONENTS AND PARTS

B. DIAGRAM OF SPEEDOMETER

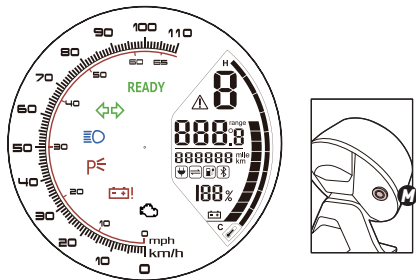

M M bottom instruction

Displacement switching Range/Temperature

In normal mode, press the switch for one second, turned into force switch and keep the status.

Manually start the back light of Speedometer (Back light for Letters + LCD back light)

In normal mode, press it longer than two seconds but shorter than 8 seconds, start the back light for speedometer and head light.

 OBD diagnosis Prompt error code

Refer to the introduction of error code on P24

 Data connecting

 NORMAL Mode

 ECO Mode

 Charging

 Battery error

 High beam indicator

 Prompt fault code

 Winker indicator light on

 Parking Light

Change between KM/Mile and KM/P & MPH

In normal mode, press it longer than 8 seconds, then release. Press it less than 2 seconds, change indications, and keep the status.

Press it longer than 2 seconds but shorter than 8 seconds, start the back light for speedometer and head light.

Press it longer than 8 seconds, then release.

OPERATION GUIDE

A. LEFT SWITCH

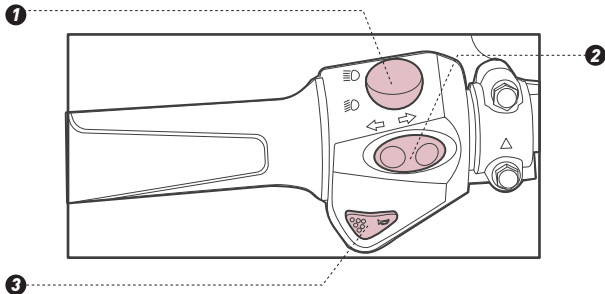
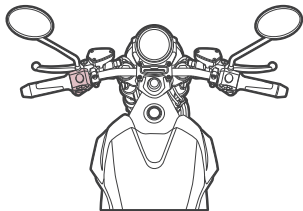

1 High/low beam switch

Up position, high beam on;
Down position, low beam on.

2 Winker switch

Turn to left, left winker on;
Turn to right, right winker on.

3 Right switch

Press, horn on; release, horn off.

OPERATION GUIDE

B. RIGHT SWITCH

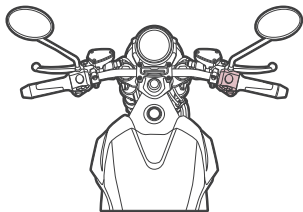

1 Front Light switch

Up position, front light on; Down position, front light automatically on. (Front light adjust the lightness automatically according to environment)
Remark: The front light always on at EEC state.

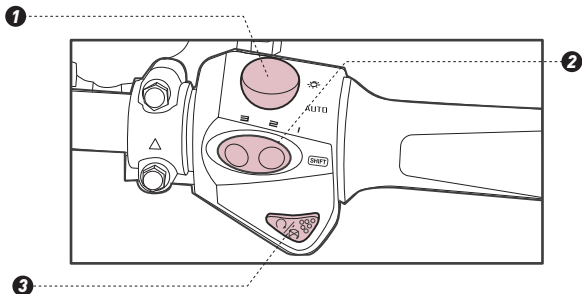

2 Mode switch

TC-MAX is set with 3 modes:
1: ECO mode 2: NORMAL mode 3: SPORT mode.
Position at left, mode 1;
position in the middle, mode 2;
position at right, mode 3.

3 Parking switch

Press, light on, TC-MAX at parking position;
Press again, TC-MAX ready to ride.

OPERATION GUIDE

C.REMOTO CONTROL

TC-MAX use second generation smart remote control, within 50 meter radius, press the button, can lock or unlock your TC-MAX.

D.LOCK

LOCK, when TC-MAX in resting state, press "LOCK", "POWER" flash, TC-MAX locked.

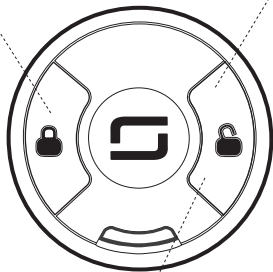

E.UNLOCK

UNLOCK, When TC-MAX in lock state,press "UNLOCK", "POWER" continuously on,TC-MAX unlocked.

F.POWER

After unlocking TC-MAX via remote control, press the "POWER", power on, press again, power off.

"POWER" flash, locked status.

"POWER" continuously on, stand-by status

Red circle continuously on, TC-MAX ready to ride.

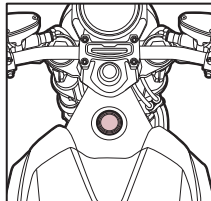

OPERATION GUIDE

g.HANDLEBAR LOCK

- 1** TC-MAX in parking position, turn handlebar to the extreme left position, put key in handlebar lock, and turn the key to right position, handlebar locked.
- 2** Put the key in handlebar lock, turn the key to left position, handlebar unlocked.

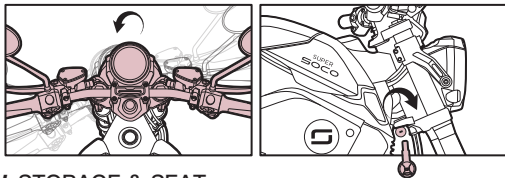

h.STORAGE & SEAT

- 1** Put key in storage&seat lock, turn key to right direction, when hear sound “click”, storage open.
- 2** Put key in storage&seat lock, turn key to left direction, seat open.

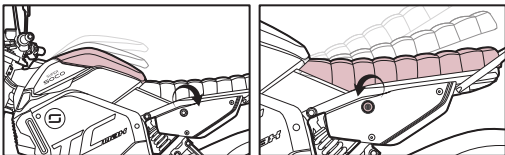

OPERATION GUIDE

g.KILL SWITCH

Kill switch, protect power, when current over than set range cause by abnormal situation or short circuit, kill switch will stop the connection between battery and TC-MAX automatically, for safety reason.

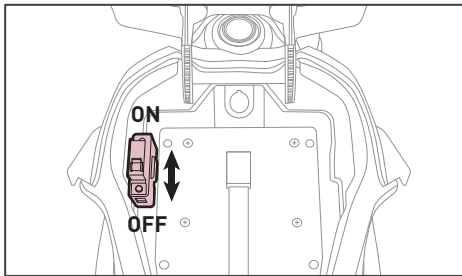
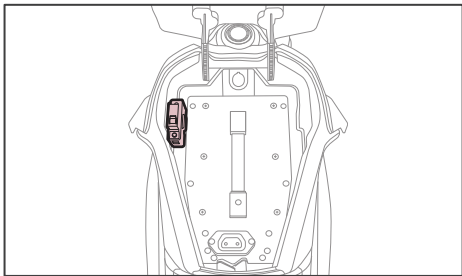

TIPS: For your own safety, please put kill switch at “OFF” position:

- A. Before taking out battery pack;
- B. Before cleaning and washing;
- C. Long time storage.

RIDING GUIDE

a. CHECKING LIST BEFORE RIDING

Make sure to check the following items before riding your TC-MAX

- 1 Whether the handlebar is stable and flexible when turning.
- 2 Whether the right and left switches on the handlebar can work properly or not.
- 3 Whether the accelerator can work properly or not.
- 4 Make sure the tyre pressure is connect. The recommended tire pressure is 200Kpa for front wheel, 225Kpa for rear with rider only and 200Kpa for front wheel,250Kpa for rear when 1 rider with 1 passenger.
- 5 Check tyre surface, make sure no cracks, damage, and foreign matter puncture or attachment.
- 6 Whether the tread depth is enough,such as worn to the black shadow position on the sketch ,tyre need to be replaced.
- 7 Whether the belt has abrasion, cracks, broken teeth or not.
- 8 Whether there are stones or other foreign bodies in the belt teeth or not.
- 9 Whether any error warning light in the speedometer with power on or not.
- 10 Whether the battery capacity is enough for your trip.
- 11 Whether all light work properly or not.
- 12 Whether the horn work properly or not.
- 13 Whether the mirrors are clean and adjust them to the appropriate angle.
- 14 Whether the brake oil is enough, whether the brake lever and brake system work properly or not.

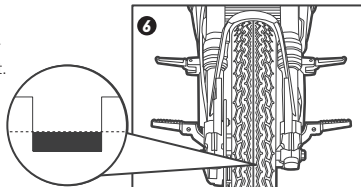

Any exceptions or operational doubts, please contact Super SOCO official dealer's service center.

RIDING GUIDE

b. POWER ON

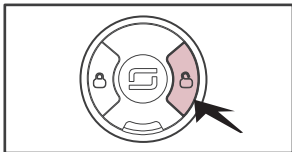

- ❶ Press “UNLOCK” on remote control, “POWER” continuously

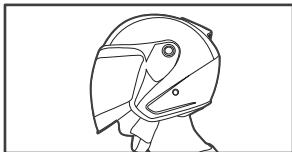

- ❷ Put on helmet.

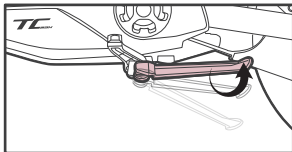

- ❸ Riding TC, kick out side stand.

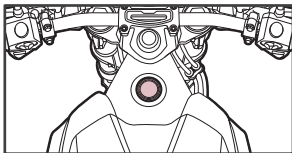

- ❹ Press “POWER”, power on.

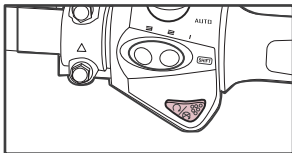

- ❺ Press ‘Parking’ button, unpacking TC-MAX, parking symbol off.

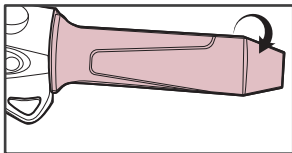

- ❻ Turn throttle gently, TC-MAX run

RIDING GUIDE

TIPS:

- ❶ Before riding, make sure side stand is kicked out, handlebar is unlocked.
- ❷ DON'T press "PARKING" during riding, in case any dangerous due to motor power off and in parking status.
- ❸ DON'T put side stand at standing position, in case any dangerous due to motor power off and in standing status.
- ❹ TC-MAX need to power on under steady standing status. In case any unusual situation, please move the bike to side of the road, in case any dangerous, please don't restart the bike when it still running or in the middle of the road.

c. NOTICE

- ❶ After the riding start, it should accelerate slowly to avoid excessive starting current caused by instantaneous rapid acceleration and increase energy consumption
- ❷ Under the premise of ensuring safety, try to keep a constant speed on the way you are driving, reduce frequent starts, brake, instant acceleration, etc.
- ❸ The maximum load of TC-MAX is 150KG. Overload is strictly prohibited
- ❹ Press "Parking" switch while pushing the bike, in order to prevent the unintentional handlebar rotation causing an accident.
- ❺ Please turn off the power while packing and remove the key

BATTERY USE INSTRUCTION

a.CHARGING ON-BOARD

- 1 Connect the charger to TC-MAX charging port.
- 2 Connect the charger with power supply, during normal charging, red light keeps on.
- 3 When fully charged, green light keeps on.

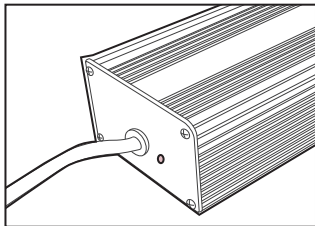
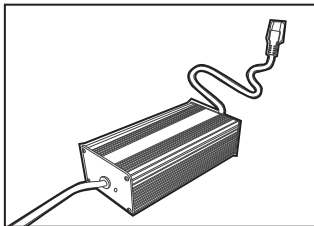

Battery Charging Display

Charging: Red light on.

Full Charged: Green light on.

Error: Red light, green light blink.

BATTERY USE INSTRUCTION

b. External charging

- 1 Open storage, switch off kill switch, take out storage cover.
- 2 Disconnect the power plug.
- 3 Put key in battery lock, turn to right, then can take out the battery pack from bike.
- 4 Connect charger with battery, then connect charger with power supply, charger working, red light keeps on.

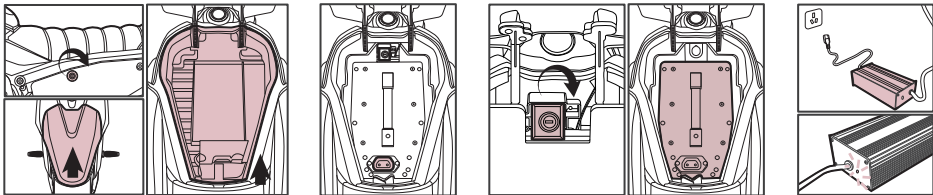

TIPS:

- 1 Keep battery pack away from water;
- 2 Charging temperature: 0 – 40°C, discharging temperature: -15 – 45 °C;
- 3 Charging battery pack after using, if don't use the bike for long time, must take out battery pack from bike.
- 4 Forbidden to short circuit positive and negative pole at battery pack input and output position.
- 5 Forbidden to children touch the battery pack and put the battery pack into fire;
- 6 Forbidden to strong impact and press on battery pack;
- 7 Must use official charger, forbidden to use any other charger to charge battery pack;
- 8 Before delivery, battery pack already passed quality checking, forbidden to open the battery pack;

BATTERY USE INSTRUCTION

c.Storage、maintenance、transport

- ❶ In case long time no use battery, please charge it till 50% (in case battery is empty, charge the battery pack 5 hours is enough). Disconnect the battery from bike when storing them. Store in dry ventilated place, at least charge 4 hours each 2 months.
- ❷ Battery pack and charger need to be stored in clean, dry ventilated place, avoid connect with corrosive material, stay away from power,fire,heat place.
- ❸ Battery storage condition: temperature :0 – 25 °C, humidity ≤ 65%RH.

DOWNLOAD SUPER SOCO APP

TC-MAX smart electric bike has GPRS communications, GPS locate and other functions which can be connect to your smart phone. You can manage your bike, query and do other operations by SUPER SOCO APP.

* Please note that some functions need to use wireless network and location function

At present, the mainstream mobile phone system version is iOS and Android operating system, please confirm the operating system of your smart phone before installation

Apple IOS 9.0 version and above is supported Android 4.4 version and above is supported

SUPER SOCO APP main function

- 1** Bike status: self-inspect with one button operation and understanding bike status in real time.
- 2** Multiple security: The alarm will warn, at the same time SUPER SOCO APP will send you an notification and locate the position when the bike has an illegal displacement.
- 3** Data record: Check the bike statues, remaining power, mileage, riding tracks and other information by SUPER SOCO APP.
- 4** SUPER SOCO Family bike ride: You can enjoy the online and offline travel fun by our SUPER SOCO APP. The mobile community can be turned on and interpersonal communication can be realized in a new way.

The functionality of the SUPER SOCO APP might be updated, difference will be happened due to different model and APP update. Please refer to the latest version.

REGULAR MAINTENANCE

Regular maintenance can enhance the service life and driving safety of TC-MAX. Please refer to the following suggestions and take care of your TC-MAX.

a. DAILY CLEAN AND MAINTENANCE

The new bike must do the first inspection and maintenance in the official SUPER SOCO Service Center when it reaches 1,000 km or two months (whichever comes first).

The motorcycle is recommended to do a regular inspection and maintenance in the official SUPER SOCO Service Center when it reaches each 3,000 km or six months (whichever comes first).

TIPS:

All service and maintenance must operate by official SUPER SOCO Service Center, use parts from SUPER SOCO manufacturer.

b. DAILY CLEAN AND MAINTENANCE

Cleaning: Please use clean water and neutral detergent to clean it, and use soft cloths and sponges to clean the surface; it is prohibited to use metal brushes, sandpaper or the like to clean it, in order not to scratch the parts surface. After cleaning, dry it with soft cloths.

Storage: Please park it in a dry and ventilated space to reduce the exposure to sunshine and rain, avoid rusty of parts.

TIPS:

- 1 Please switch off the kill switch before cleaning.
- 2 Do not use high pressure water to wash it directly, in order to avoid the default of mechanical parts caused by water invasion.
- 3 In case don't use for long time, please turn off kill switch and disconnect the battery from bike, prevent over discharging, please charge the battery at least 4 hours in each 2 months.
- 4 After long-term storage, please fully charge it before use.

FAQ & TROUBLE SHOOTING

a.FAQ & TROUBLE SHOOTING

Error	Causes	Solutions
No power, "POWER" not on	<ol style="list-style-type: none">1. Battery is poorly connected2. Kill switch is not turned on	<ol style="list-style-type: none">1. Connect the power cable appropriately2. Turn on the kill switch
Power on, turning accelerator, motor not run	<ol style="list-style-type: none">1. Low battery power2. Side stand is on3. At parking mode4. Brake lever does not reach the right position5. Accelerator error6. The controller plug is loose7. Controller error	<ol style="list-style-type: none">1. Charge the battery2. Kick the side stand out3. Press parking button4. Place the brake lever at the right position5. Change accelerator6. Re-plug controller7. Change controller
Speed is too slow or mileage is too short	<ol style="list-style-type: none">1. Low battery power2. Flat Tyre3. Heavily overloaded4. Brake pads need to be replaced5. Battery aging or normal scrap	<ol style="list-style-type: none">1. Charge the battery2. Pump up the tyre, check tyre pressure before riding.3. Foster a good habit, keep an appropriate load4. Change the brake pads and check the brake system before riding5. Change battery
Battery cannot be charged	<ol style="list-style-type: none">1. Poor contact of charger plug2. Used wrong charger3. Battery aging or normal scrap	<ol style="list-style-type: none">1. Check whether the battery plug is at right position or not2. Use SUPER SOCO charger3. Change battery

FAQ & TROUBLE SHOOTING









Error	Causes	Solutions
Error 99 on speedometer	Controller communication error	Please contact after sales service or dealer
Error 98 on speedometer	Controller stop working(Possible over current,motor blocking,under voltage,over temperature)	Please stop riding and wait for a while then restart or contact after sales service or dealer
Error 97 on speedometer	Controller power tube error	Please contact after sales service or dealer
Error 96 on speedometer	Controller hall sensor error	Please contact after—sales service or dealer
Error 95 on speedometer	Controller hall sensor error	Please check the accelerator plug or contact after sales service or dealer—sales service or dealer
Error 94 on speedometer	Battery communication error	Please check the battery plug or contact after sales service or dealerservice or dealer
Error 93 on speedometer	Charging, over current error	Please stop charging and check the charger
Error 92 on speedometer	Charging, over voltage error	Please stop charging and check the charger
Error 91 on speedometer	Battery over temperature error	Please stop riding or charging and wait for a while

FAQ & TROUBLE SHOOTING

Error	Causes	Solutions
Error 90 on speedometer	Battery discharging over current error	Please stop riding if keep showing and contact after sales service or dealer
Error 89 on speedometer	Battery charging low temperature error	Please move the bike to warm indoor place and wait for a while
Error 88 on speedometer	Battery discharging low temperature	Please move the bike to warm indoor place and wait for a while
Error 87 on speedometer	Network connection error	Please move the vehicle to open area and wait for a while or contact after sales service or dealer
Error 86 on speedometer	GPS connection error	Please move the vehicle to open area and wait for a while or contact after sales service or dealer

FAQ & TROUBLE SHOOTING

b. BELT WEAR ANALYSIS

Error	Causes	Solutions
	In the case of internal tooth crack(in the shape of hair):	Running under supervision;
	In the case of out tooth crack:	Replace the belt;
	In the case of missing tooth:	Replace the belt
	In the case of blurred core edge:	Running under supervision;
	In the case of slight chipping:	Running under supervision;
	In the case of blurred core edge:	Running under supervision;
	In the case of edge damage due to stone:	Replace the belt;
	In the case of the inclined exterior margin plane only:	Running under supervision;

Please do not check the belt tension in cases that the belt is exposed to rain, cleaned in 24 hours or running in working temperature within 4 hours. Before belt tension testing, please allow the bike cool down to room temperature; if the belt has been running over 5000 miles (8000 km) in damage or fault condition, please replace the belt and two chain wheels together. Attention: such replacement needs a professional worker, please contact the service after sales or dealer.

FAQ & TROUBLE SHOOTING

c.BATTERY FAULT REMOVAL

Battery Status	Issues	Causes	Solution
Before using	Battery runs out, unable to activate the bike	Battery no power	Please charge the battery
In Operation	In battery low power mode. Battery below 10% ,bike power-off	Battery runs out, low-voltage protection	Please charge the battery
In Operation	Display 88 Error code	Battery discharging low temperature	Please move the bike to warm indoor place and wait for a while
In Operation	Display 90 error code	Battery discharging over current error	Please stop riding if keep showing and contact after sales service or dealer
In operation	Display 91 error code	Battery over temperature error	Please stop riding or charging and wait for a while
In Operation	Display 94 error code	Battery communication error	Please check the battery plug or contact after sales service or dealer
In Operation	Display power reduce, over night or the next day.	ECU, controller and alarm components take power from battery automatically, normal phenomena.	Normal use
In Operation	Mileage different from the official announced	Official announced mileage is tested under specific circumstances and states. Affected by different road condition, weather, temperature, windage, loading ect.	Any questions, please contact after sales service or dealer

FAQ & TROUBLE SHOOTING

Battery Status Issues		Causes	Solution
Storage	Press “Start” , no power	The battery is stored too long time, battery runs out	Please charge the battery. If it is not possible to charge, please contact after sales service or dealer
In Charge	Display 89 error code	Charging at low temperature	Please charge the battery in room temperature.
In Charge	Display 92 error code	Charging overage	Stop charging the battery, check the charger
In Charge	The charger gets hot during charging	In the charging process, the internal current of the charger is too high, produce large amount of heat. The metal shell can effectively dissipate heat, which will lead to the high temperature of the shell	Please use normally, charge in dry and ventilated place
Battery water penetration	The battery is not working properly, unable to start the bike.	Bike in the rain, in the water, wading across deep causing battery flood.	Please stop using, contact service after sales or dealer
Battery box broken	Battery shell broken caused by clash or dorp from high place.	Battery shell broken	Please stop using, contact service after sales or dealer

CHECK LIST

RANGE	1000KM	3000KM	6000KM	9000KM	12000KM	15000KM	18000KM	21000KM	24000KM	Torque (N·m)
Brake fluid"	<input type="radio"/>		<input type="radio"/>				<input type="radio"/>			
Tire pressure and wear"	<input type="radio"/>	<input type="radio"/>	<input type="radio"/>	<input type="radio"/>		<input type="radio"/>	<input type="radio"/>	<input type="radio"/>		
Brake shoe wear degree before and after"		<input type="radio"/>	<input type="radio"/>	<input type="radio"/>		<input type="radio"/>	<input type="radio"/>	<input type="radio"/>		
Before and after the disc brake wear"			<input type="radio"/>				<input type="radio"/>			
Front axle nut fastening"	<input type="radio"/>		<input type="radio"/>				<input type="radio"/>			59
Tighten the rear flat fork nut"	<input type="radio"/>		<input type="radio"/>				<input type="radio"/>			59
Rear wheel axel nut	<input type="radio"/>		<input type="radio"/>				<input type="radio"/>			88
Front shock bolt fastening	<input type="radio"/>		<input type="radio"/>		<input checked="" type="radio"/>		<input type="radio"/>		<input checked="" type="radio"/>	Upper:22 Lower:32
Rear shock bolt fastening	<input type="radio"/>		<input type="radio"/>				<input type="radio"/>			45
Steering column locking nut"	<input type="radio"/>		<input type="radio"/>				<input type="radio"/>			74
Front disc brake bracket fastening (coated glue thread)"	<input type="radio"/>		<input type="radio"/>				<input type="radio"/>			26
Front disc brake (with fastening screw glue)"	<input type="radio"/>		<input type="radio"/>				<input type="radio"/>			42
After the disc bracket fastening (coated glue thread)"	<input type="radio"/>		<input type="radio"/>	<input type="radio"/>			<input type="radio"/>			26
After the brake disc (with fastening screw glue)	<input type="radio"/>		<input type="radio"/>	<input type="radio"/>			<input type="radio"/>			42
Drive belt and pulley	<input type="radio"/>	<input type="radio"/>	<input type="radio"/>	<input type="radio"/>		<input type="radio"/>	<input type="radio"/>	<input type="radio"/>		
Battery"	<input type="radio"/>	<input type="radio"/>	<input type="radio"/>	<input type="radio"/>		<input type="radio"/>	<input type="radio"/>	<input type="radio"/>		

Remark: Lithium battery test by BMS software and voltage measure by manual operation

www.supersoco.com

***SOCO wish you
a happy voyage***

Download APP



Bind APP

请粘贴
二维码

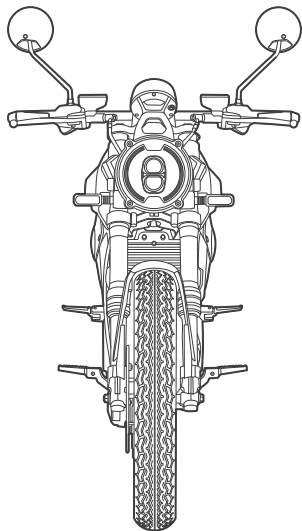



TLC*max*

Follow us



SUPER SOCO World

www.supersoco.com



Scan QR code to
download e-user manual

USER MANUAL